

Esploso Alicudi  
Spare Part List Alicudi  
Explosionszeichnung Alicudi



## Contents

1.	Bodywork parts .....	3
2.	General hydraulic exploded views .....	6
3.	General multiboiler hydraulic exploded view.....	8
4.	Flexible connections.....	10
5.	Vibratory pump exploded view .....	11
6.	Rotative compact pump exploded views.....	12
7.	Brewing group exploded view .....	13
8.	Labyrinth exploded view.....	14
9.	Porta-filter exploded view.....	14
10.	Water and steam tap exploded view.....	15
11.	Boiler exploded view. ....	16
12.	Water inlet assembly exploded view.....	18
13.	Electronic diagrams.....	19
14.	Electronic diagrams, multi-boiler version. ....	20
15.	Hydraulic diagrams. ....	22
16.	Hydraulic diagrams multi-boiler version. ....	24
17.	Electric and electronic devices.....	26

## 1. Bodywork parts.

### FRONT PANELS

Description	Item code
FRONTAL LEVA 1 GR OFFICE S.STEEL	10000125
FRONTAL LEVA 1 GR WITH DISPLAY (Before 2011)	10000128-D
FRONTAL LEVA 1 GR WITH DISPLAY	10000128



10000125



10000128

### BODYWORK

Description	Item code
BODYWORK OFFICE LEVA	10000405

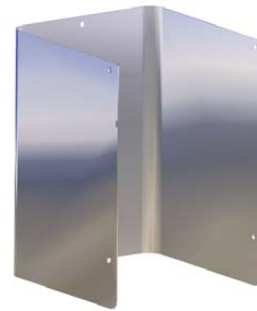

### CUP TRAY AND CUP TRAY TUBE

Description	Item code
CUP TRAY WITHOUT TANK OFFICE LEVA	10000072
CUP TRAY OFFICE LEVA 1 GR	10000075
CUP TRAY TUBE OFFICE- 6 mm	10001055

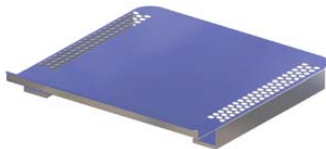

10000072

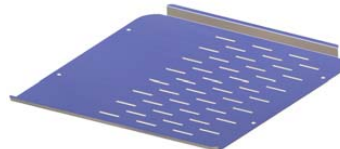

10000075



10001055

### DIVIDER

Description	Item code
TANK DIVIDER SET LEVA	10000136



### TRAY

Description	Item code
DRAIN TRAY. S.STEEL OFFICE LEVA	10000260



# 1. Bodywork parts

## GRILL

Description	Item code
DRIP GRILL OFFICE LEVA	10000210

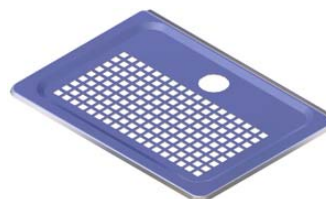

## FRONTAL

Description	Item code
LOWER TRIM OFFICE LEVA	10000155



## FEET

Description	Item code
FOOT OFFICE	70000040
FOOT D-30 MOD. CUPS	70000041



70000040



70000041

## 2. General hydraulic exploded views

EXPLODED VIEW OFFICE LEVA TANK CONNECTION.

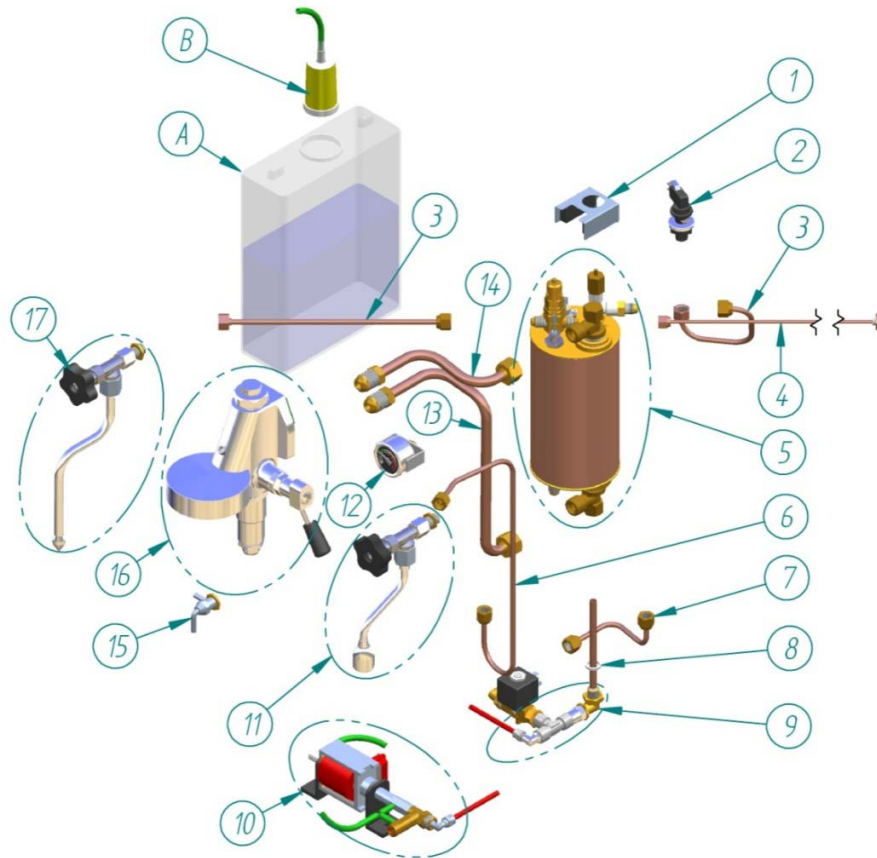

EXPLODED VIEW OFFICE LEVA WATER NETWORK CONNECTION

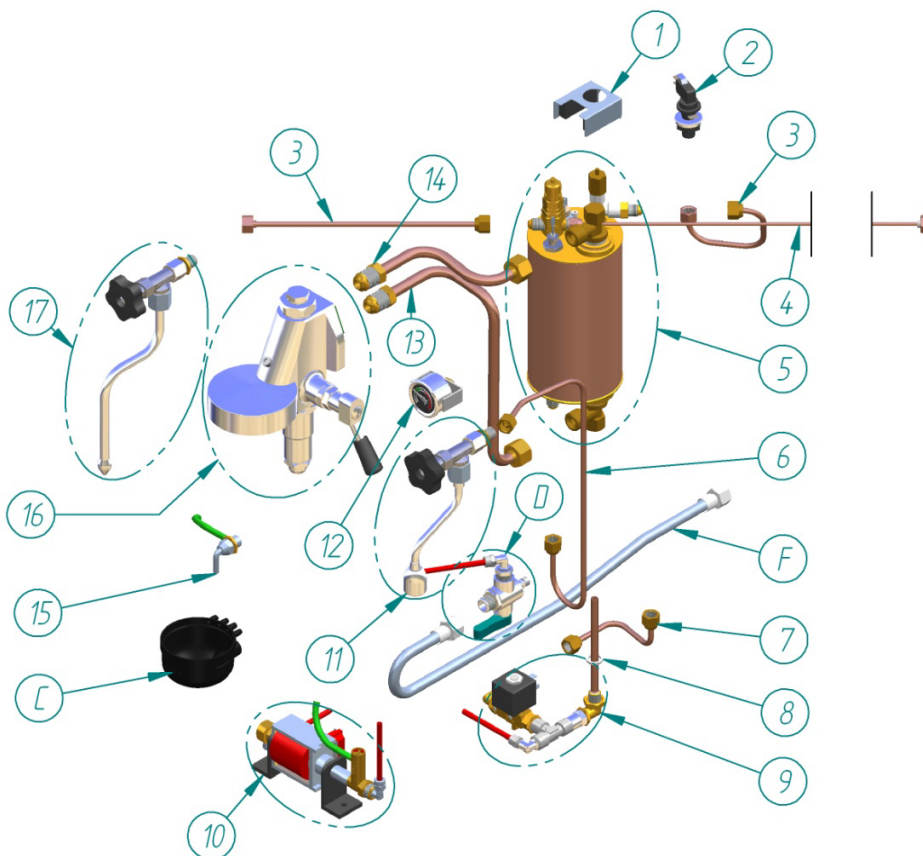

## 2. General hydraulic exploded views

### OFFICE LEVA TANK OR WATER NETWORK CONNECTION

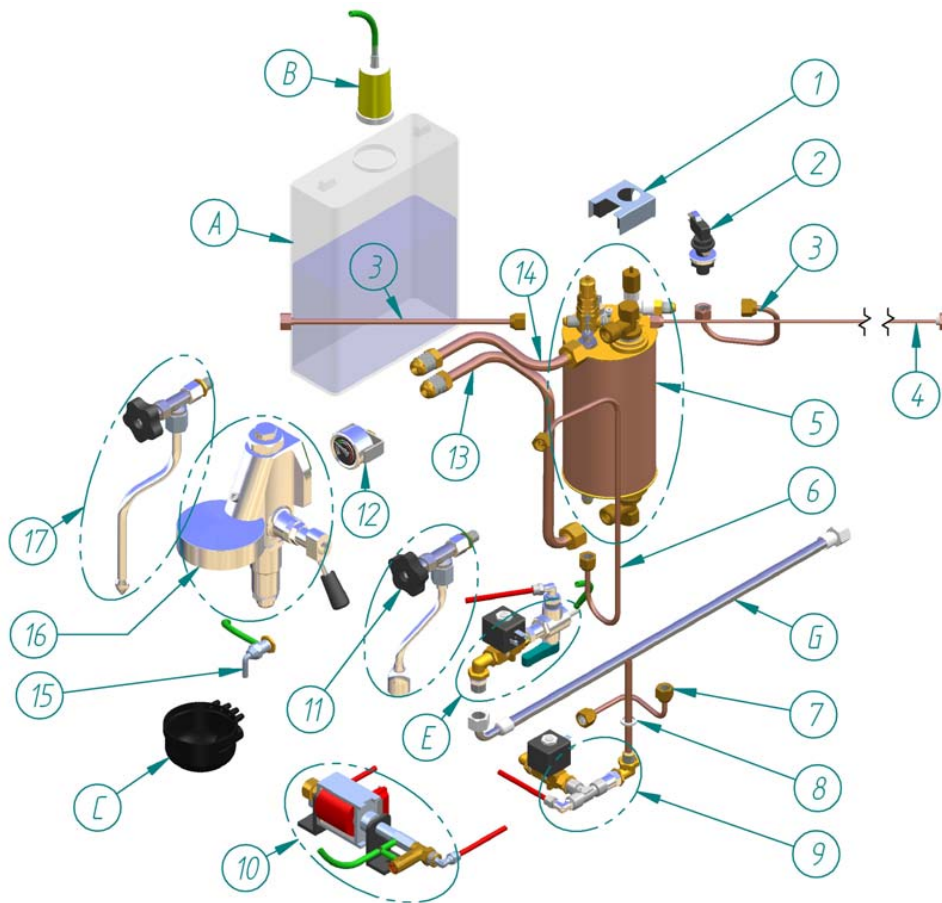

N°	Description	Item code
1	MAGNETS SET	ESC00100
2	PRESSURE STAT PIRIS CE	60000008
3	PRESSURE STAT TUBE 4 LT	35040106
4	MANOMETER TUBE	35110530
5	BOILER ASSEMBLY.	-----
6	WATER TUBE OFFICE DOME	35030261
7	BOILER CHARGE TUBE OFFICE	35020040
8	TEFLON GASKET 1/4 (13.2x18.2x2.5)	50010020
9	LABYRINTH OFFICE AND 2 BOILERS	ESC00250
10	VIBRATORY PUMP ASSEMBLY	-----
11	WATER TAP ASSEMBLY OFFICE LEVA CREM	-----
12	1 READING MANOMETER D40 ORMAN	60000062
13	GROUP RETURN TUBE OFFICE	35020003
14	INLET TUBE GROUP OFFICE	35020004
15	OUTLET RACCORD OFFICE LEVA	30400130
16	LEVA GROUP	15000000
17	STEAM WAND + TAP ASSEMBLY OFFICE LEVA	-----
A	OFFICE PLASTIC TANK H-245-3L	70000100
B	WATER SOFTENER OFFICE	10200420
C	DRAIN CUP + HIGH GROUP	70001000
D	INLET WATER ASSEMBLY ,NETWORK VERSION	-----
E	INLET WATER ASSEMBLY, VERSION NETWORK OR TANK	-----
F	FLEXIBLE HOSE 100 CM	35900100
G	FLEXIBLE HOSE 55 CM ELBOW	35900045



### 3. General multiboiler hydraulic exploded view.

OFFICE LEVA MULTIBOILER CONNECTION TANK.

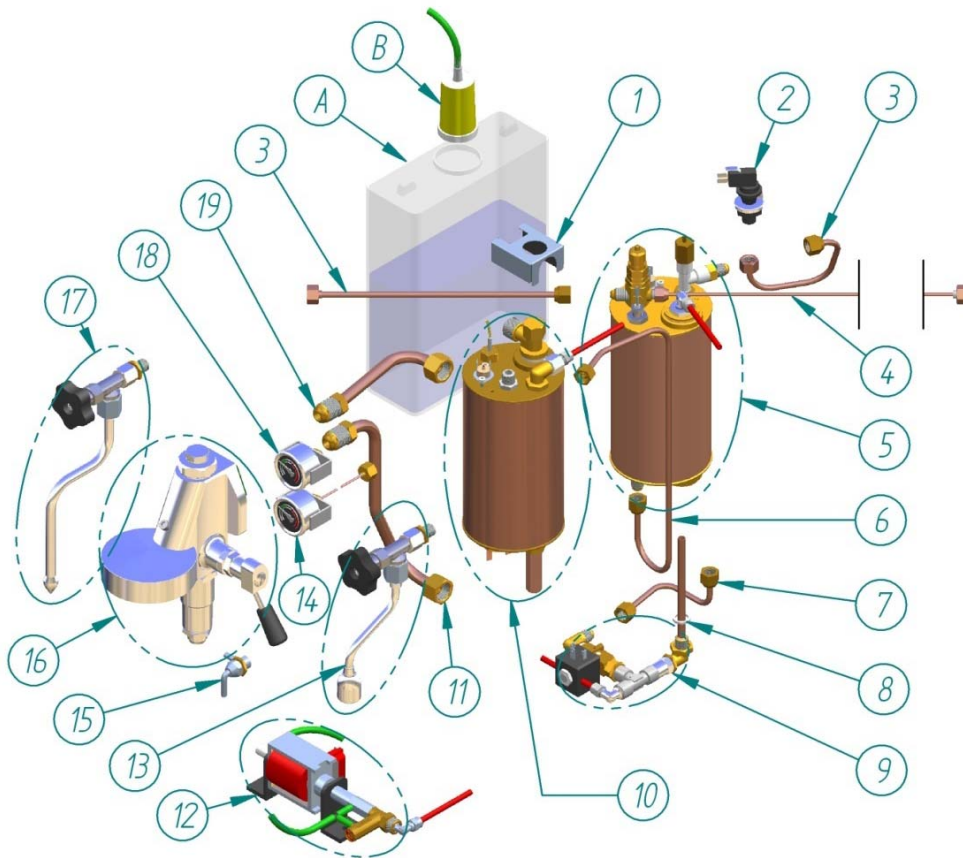

OFFICE LEVA MULTIBOILER WATER NETWORK CONNECTION.

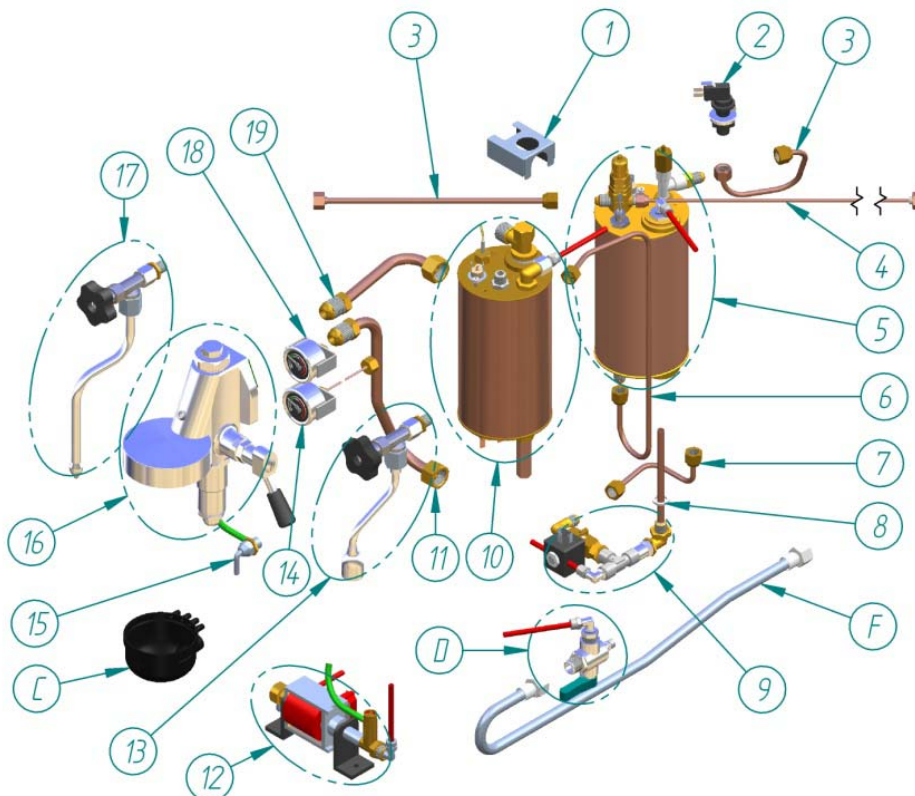

### 3. General multiboiler hydraulic exploded view.

OFFICE LEVA MULTIBOILER TANK OR WATER NETWORK CONNECTION.

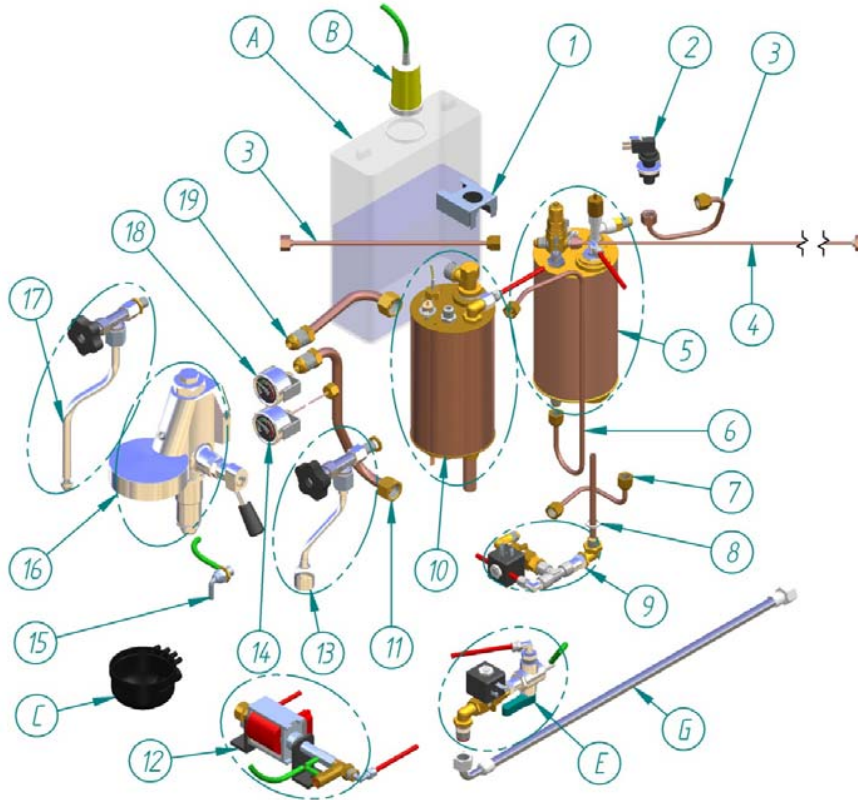

OFFICE LEVA MULTIBOILER WITH ROTATIVE PUMP, WATER NETWORK CONNECTION.

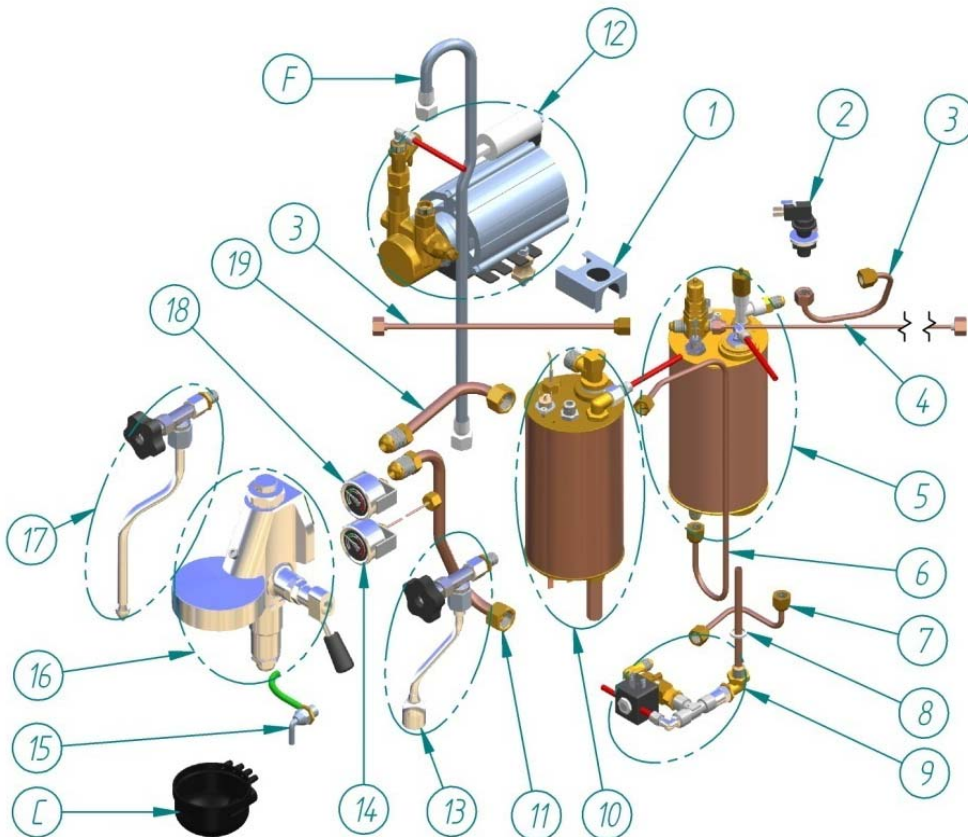



### 3. General multiboiler hydraulic exploded view.

N°	Description	Item code
1	MAGNETS SET	ESC00100
2	PRESSURE STAT PIRIS CE	60000008
3	PRESSURE STAT TUBE 4 LT	35040106
4	MANOMETER TUBE	35110530
5	BOILER ASSEMBLY.	-----
6	WATER TUBE OFFICE DOME	35030261
7	BOILER CHARGE TUBE OFFICE	35020040
8	TEFLON GASKET 1/4 (13.2x18.2x2.5)	50010020
9	LABYRINTH OFFICE AND 2 BOILERS	ESC00250
10	CAPUC. BOILER ASSEMBLY OFFICE LEVA	-----
11	LEFT RETURN TUBE MINI	35040006
12	PUMP ASSEMBLY	-----
13	TAP WATER ASSEMBLY OFFICE LEVA CREM	-----
14	MANOMETRE D40 O-16 BAR	60000072
15	OUTLET RACCORD OFFICE LEVA	30400130
16	LEVA GROUP	15000000
17	STEAM TAP + WAND ASSEMBLY OFFICE LEVA	-----
18	1 READING MANOMETER D40 ORMAN	60000062
19	TUBE D12 ENTRY GRINDER OFFICE	35040476
A	PLASTIC TANK OFFICE H-245-3L	70000100
B	WATER SOFTENER OFFICE	10200420
C	CACILLO DESAGÜE + VASO ALTO	70001000
D	WATER INLET ASSEMBLY , NETWORK CONN. VERSION	-----
E	INLET WATER ASSEMBLY, TANK OR NET CONN. VERSION	-----
F	FLEXIBLE HOSE 100 CM	35900100
G	FLEXIBLE HOSE 55 CM ELBOW	35900045

### 4. Flexible connections.



Description	Item code
MTS SYLICONE TUBES 4x7 PUMP INLET	35021000



Description	Item code
MTS TEFLON TUBE 4 x 6	35021015



Description	Item code
CONNECTOR FOR SYLICONE TUBE 4x6	60100056

## 5. Vibratory pump exploded view

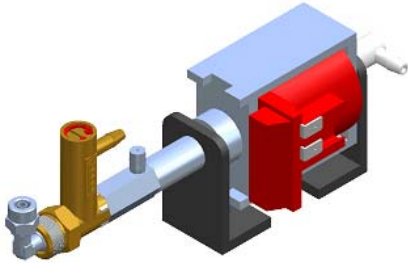

TANK CONNECTION.

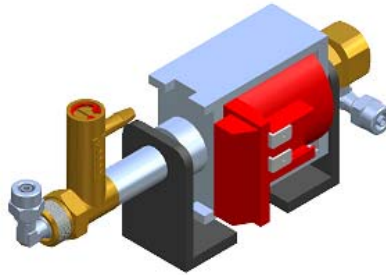

W. NET CONNECTION

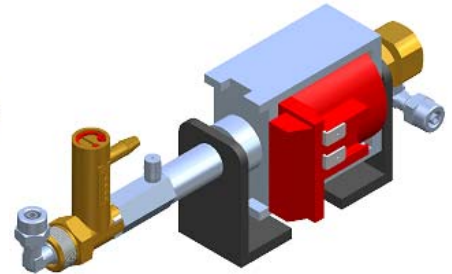

NET OR TANK CONNECTION.

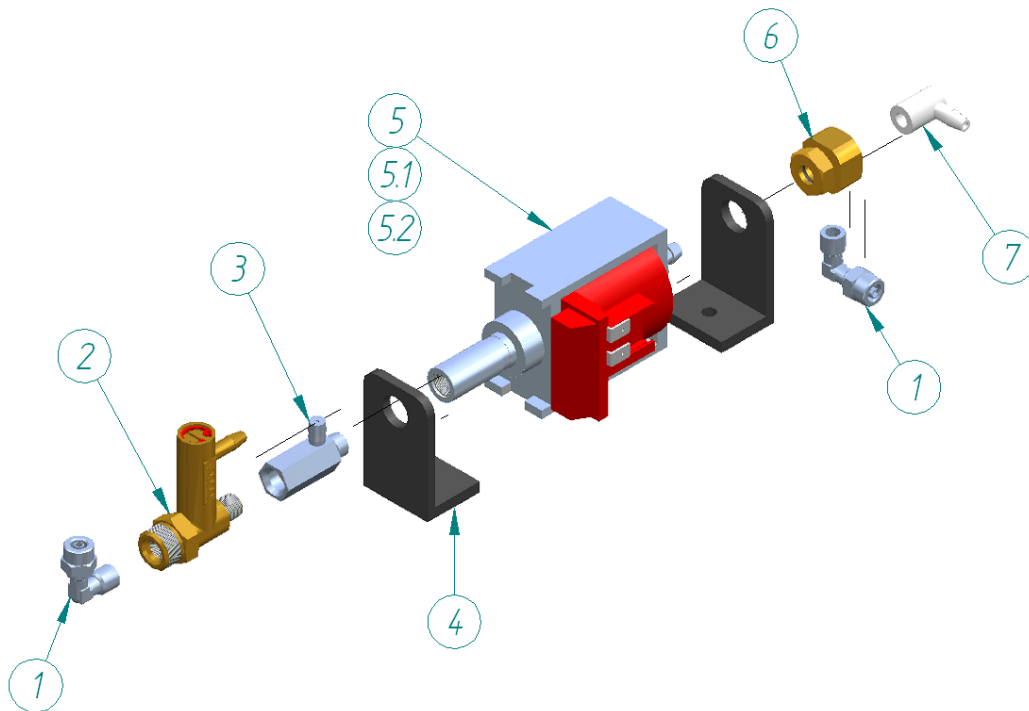

N°	Description	Item code
1	MALE ELBOW 1/8 TUBE 6 PUMP	30400010
2	PUMP BYPASS	30400055
3	AIR RELIEF PUMP	65000215
4	SUPORT L OFFICE PUMP	30400060
5	OFFICE PUMP 220V 50Hz	60000040
5.1	OFFICE PUMP 220V 60Hz	60000045
5.2	OFFICE PUMP 110V 60Hz	60000047
6	RACCORD CONNECTION BOMBA NET	30400100
7	OFFICE PUMP PIPET	30400070

## 6. Rotative compact pump exploded views.

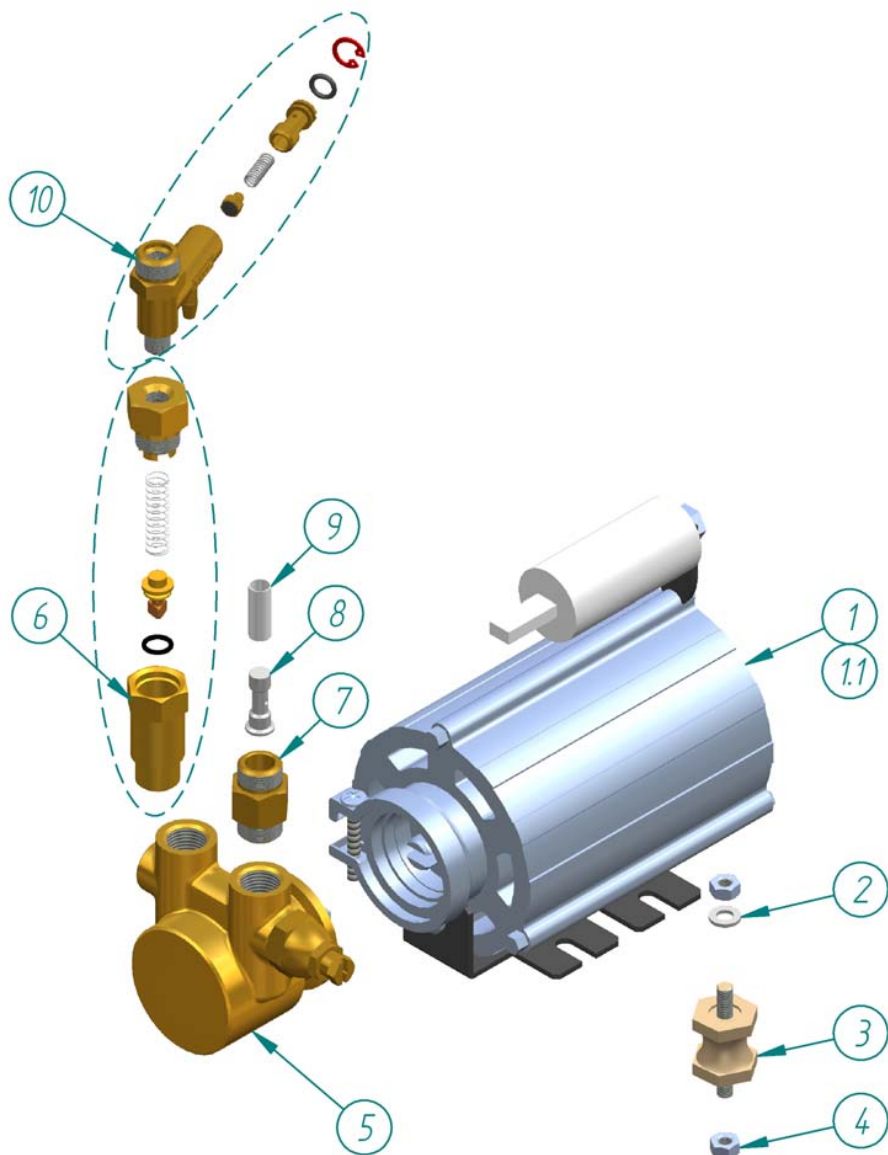

N°	Description	Item code
1	COMPACT MOTOR 220V	60000022
1.1	COMPACT MOTOR 115V	60000023
2	WASHER. DIN 125 -M6 - A2 FLAT	25012520
3	SILENTBLOK M-6	50100000
4	WASHER DIN 934 - M6 A2 HEX	25093420
5	COMPACT PUMP	60000033
6	RETENTION VALVE 3/8 * 1/8 (min-mon-ec)	65000015
7	PUMP RACCORD 3/8 x 3/8 PORTA-FILTER	30000240
8	TEFLON PORTA-FILTER WATER INLET	30100100
9	GROUP TUBULAR FILTER	70000009
10	PUMP BYPASS	30400055

## 7. Brewing group exploded view

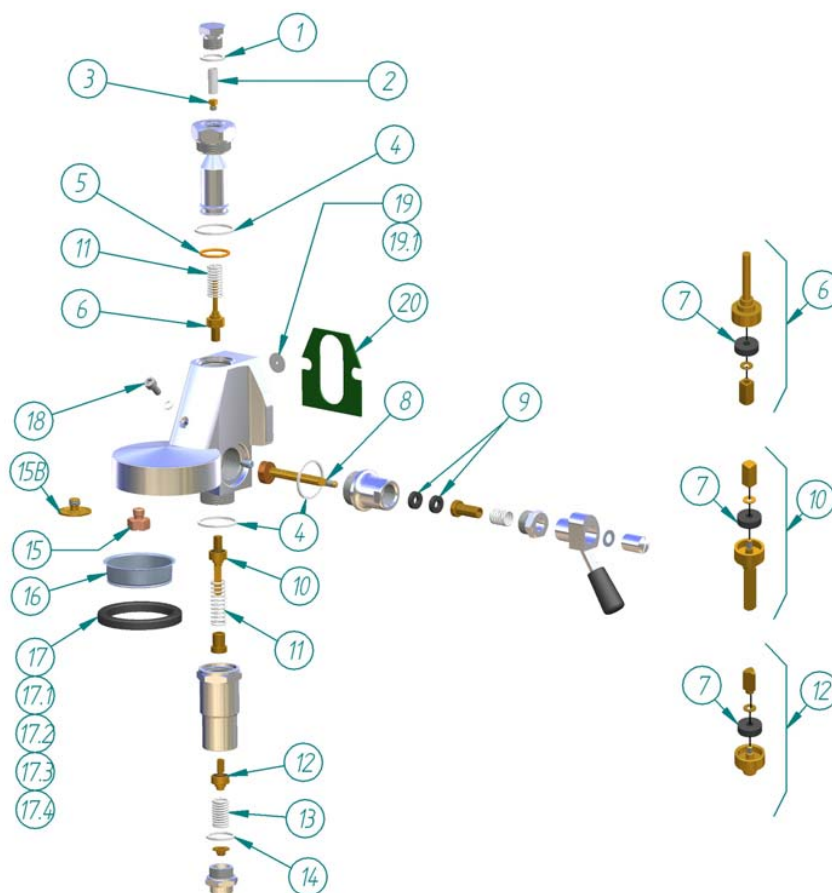

N°	Description	Item code
1	TEFLON GASKET P	CTAV1-30
2	GROUP TUBULAR FILTER	70000009
3	TRUMPET REDUCER GROUP CREM	30200050
4	TEFLON GASKET 35*30*2 LEVA	CTAV1-10
5	TORICA GASKET TRUMPET LEVA	CTAV1-27
6	COMPLETE BREWING VALVE LEVA	CTAV1-24
7	FLAT VITON GASKET (12.9*4*4)	50000020
8	LEVA AXIS	CTAV1-13
9	AXIS FLAT GASKET (15,5*7,5*4)	50000030
10	INFUSION VALVE	CTAV1-09
11	INFUSION VALVE SPRING LEVA	CTAV1-08
12	DISCHARGE VALVE	CTAV1-05
13	DISCHARGE VALVE SPRING LEVA	CTAV1-06
14	TEFLON GASKET 26*21*2 LEVA	CTAV1-07
15	CREM GROUP DIFFUSER	30200040
15B	LEVA DIFFUSOR SCREW (OLD)	CTAV1-11
16	SHOWER	75000010
17	PORTA-FILTER GASKET 8 EXPOBAR	75000081
17.1	PORTA-FILTER GASKET 8,5mm	75000083
17.2	PORTA-FILTER GASKET 9mm	75000085
17.3	PORTA SUPLEMENT 0.5 mm	75000090
17.4	RUBBER PORTA SUPLEMENT 1 mm.	75000095
18	SCREW DIN 912 - 6x10 A2 ALLEN	25091250
19	TEFLON REDUCER 3.5 (3.5x18.2x1)	50020000
19.1	TEFLON REDUCER 2.5 (2.5x18.2x1)	50020020
20	FLAT GASKET GROUP CHASSIS GREEN	50000010

## 8. Labyrinth exploded view.

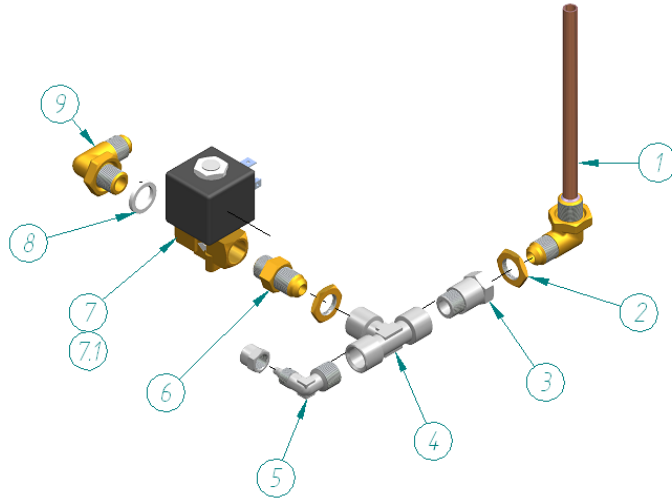

N°	Description	Item code
1	INJECTOR 1/4 CONICAL	30000220
2	COUTER NUT HEXAGONAL 1/4 PRESSURE STAT	30100010
3	UNION MALE-FEMALE 1/4 (LABYRINTH)	30400120
4	T H-H-H- 1/4 (MINI)	30000000
5	MALE ELBOW 1/4 TUBE 6 BATTERY	30400020
6	CONICAL RACCORD 1/4X1/4 ELECTRON	30000510
7	ELECTROVALVE 1/4 PARKER 220V	60000100
7.1	ELECTROVALVE 1/4 PARKER 110V-60Hz	60000103
8	TEFLON GASKET 1/4 (13.2X18.2X2.5)	50010020
9	CONIC ELBOW RACCORD /4X1/4	30000215

## 9. Porta-filter exploded view.

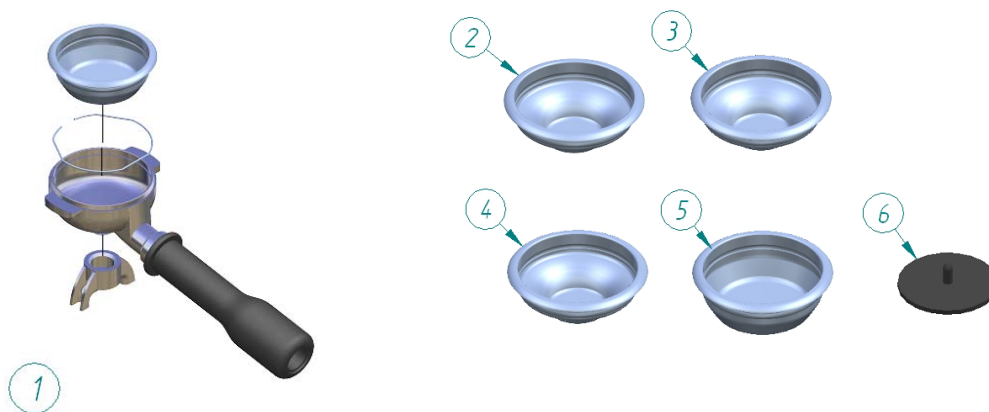

N°	Description	Item code
1	PORTA-FILTER 0 V INCLINED PLAIN	75003010
2	1 CUP FILTER 6gr	75000059
3	1 CUP FILTER 6.5gr	75000037
4	1 CUP FILTER (7GR.)	75000031
5	2 CUP FILTER (14GR.)	75000041
6	FILTER MEMBRANE	75000000



## 10. Water and steam tap exploded view

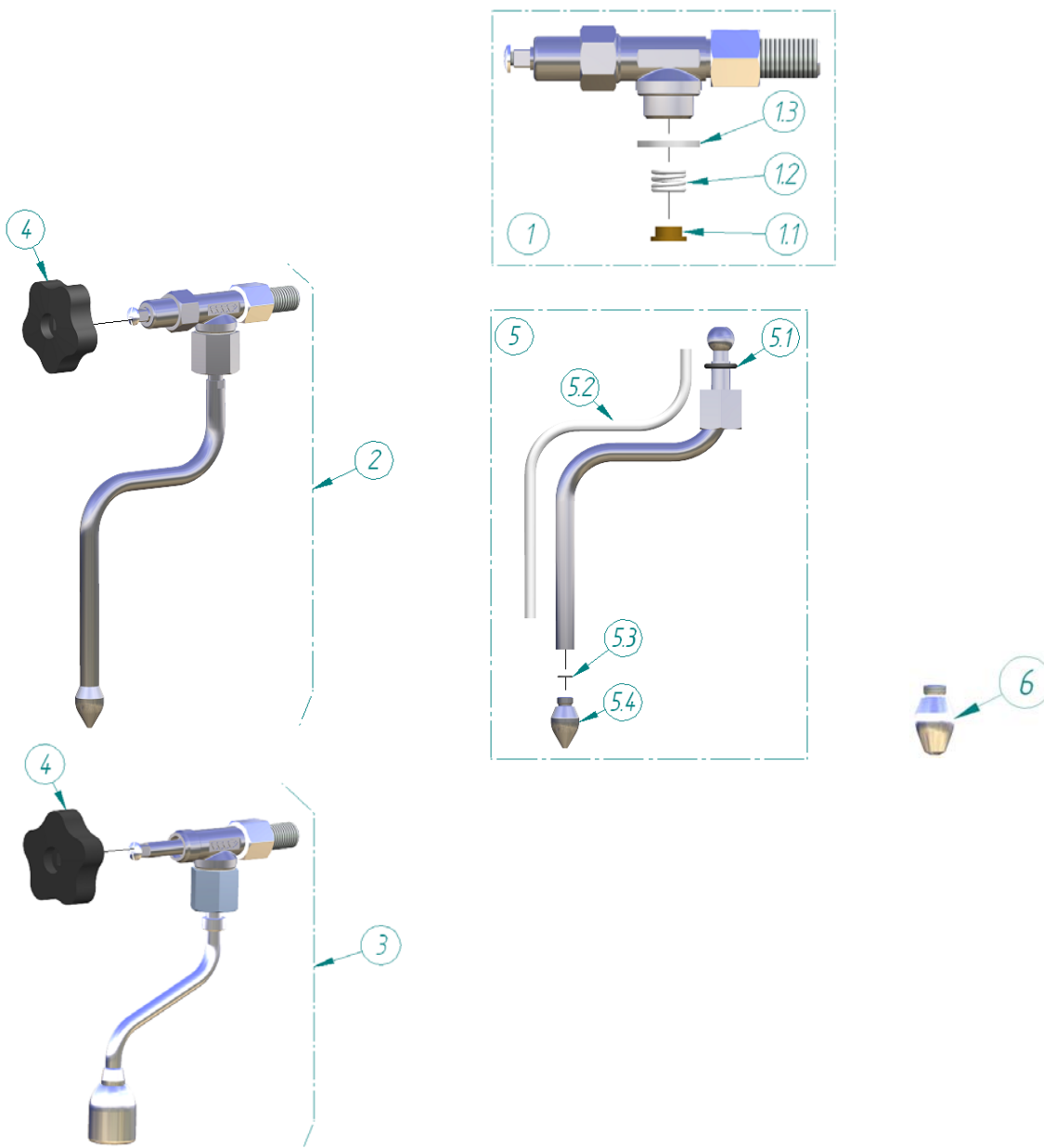

N°	Description	Item code
1	TAP BODY EB61	CTAV4-01
1.1	WAND SPRING FITTING	30370077
1.2	WAND SPRING WATER/STEAM	30370076
1.3	TEFLON GASKET W/S 3/8 (17*21*2)	50010080
2	STEAM TAP OFFICE LEVA NON-BURN	15000328
3	WATER TAP OFFICE LEVA CREM	15000337
4	TAP KNOB W/S OFFICE LEVA	40000070
5	STEAM WAND OFFICE LEVA NON-BURN	35010085
5.1	TORICA GASKET 12.1x2.7 WATER STEAM WAND	30370075
5.2	MTS TEFLON TUBE 4 x 6	35021015
5.3	TORICA GASKET 6x1 WAND NOZZLE	50010090
5.4	STEAM NOZZLE 1 F. M-8,5	30370190
6	STEAM NOZZLE 2 F. M-8,5	30370185

## 11. Boiler exploded view.

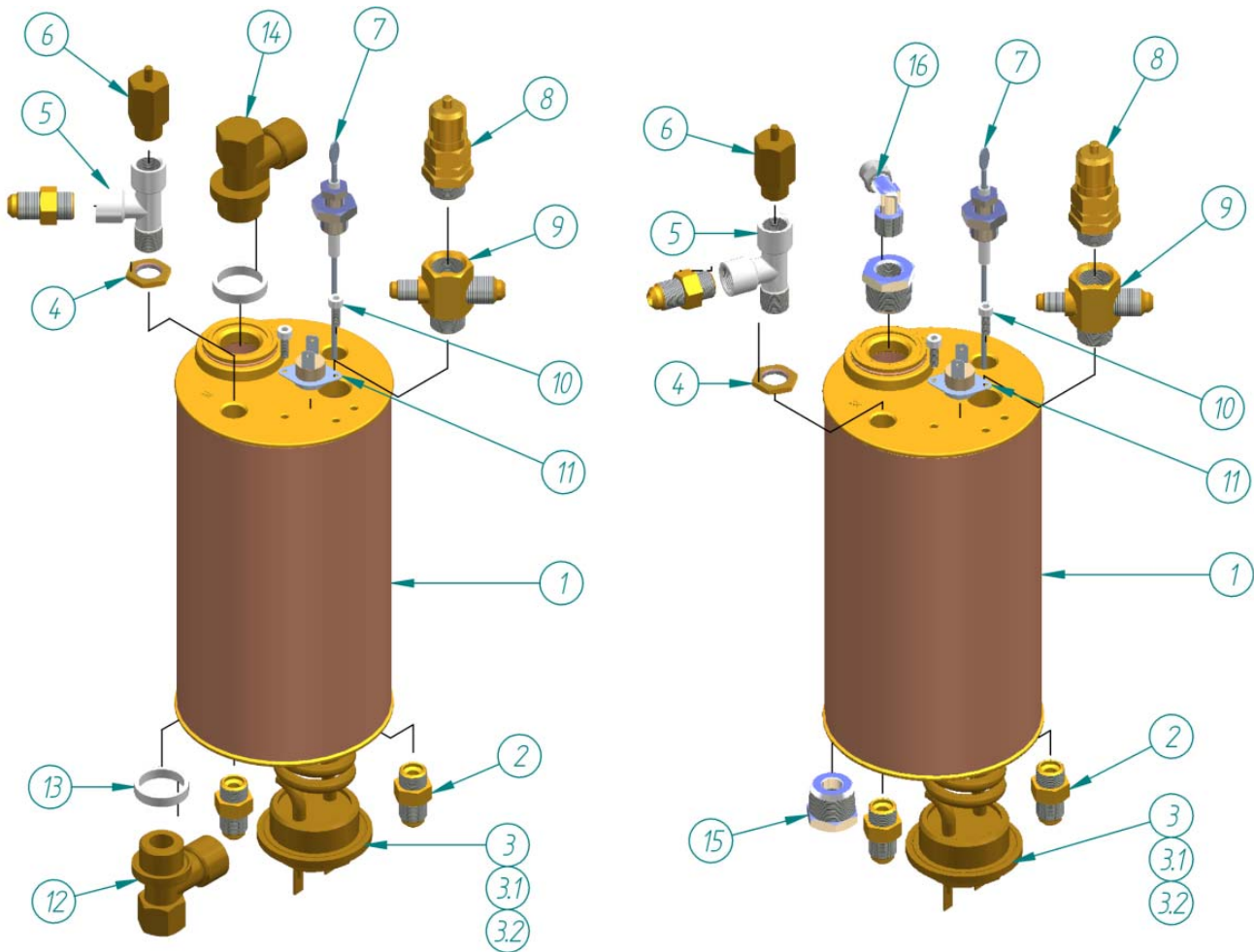

N°	Description	Item code
1	OFFICE BOILER 1.5 LITRES	15100000
2	CONICAL RACCORD 1/4 x 1/4 ELECTRON	30000510
3	ELEMENT.1200W-230V OFFICE	38012000
3.1	ELEMENT.1200/930W-125/110V OFFICE UL	38012001
3.2	ELEMENT.2000W 240V COPPER 6.25MM	38020001
4	COUNTERNUT HEXAGONAL 1/4 PRESSURE STAT	30100010
5	T 1/4H-1/4H-1/4M THREAD LATERAL	30000015
6	NON SUCTION VALVE	65000200
7	LEVEL PROBE 1/4 BRASS	60100040
8	SECURITY VALVE 3/8	65000100
9	RACCORD 2 VAYS 1/4 * 1/8	30000100
10	SCREW DIN 912 - 4x12 A2 ALLEN	25091210
11	BIMETALIC THERMOSTAT A 140 ° C	10200117
12	LOWER THERMIC RACCORD 1/2X1/2X1/4	30000210
13	THERMIC TEFLON GASKET 1/2 (21.2x25.7x5)	50010010
14	UPPER THERMIC RACCORD 1/2 X1/2	30000200
15	REDUCER 1/2 M x 1/4 H	30000011
16	MALE ELBOW 1/4 TUBE 6 BATTERY	30400020

## 10.Boiler exploded view.

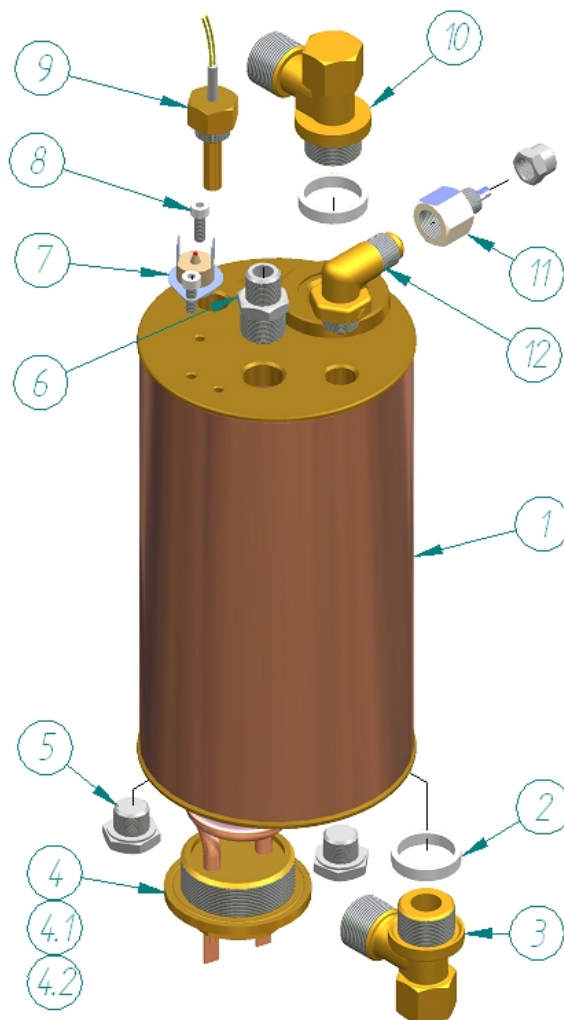

N°	Description	Item code
1	CAPUCINADOR BOILER OFFICE	15100010
2	THERMIC TEFLON GASKET 1/2 (21.2x25.7x5)	50010010
3	LOWER THERMIC RACCORD 1/2X1/2X1/4	30000210
4	ELEMENT.1200W-230V OFFICE	38012000
4.1	ELEMENT.1200/930W-125/110V OFFICE UL	38012001
4.2	ELEMENT.2000W 240V COPPER 6.25MM	38020001
5	BLIND PLUG 1/4 MALE	30000300
6	MACHON 1/4-3/8 (MINI)	30000002
7	OFFICE THERMOSTAT 16 A	10200110
8	SCREW. DIN 912 - 4x12 A2 ALLEN	25091210
9	BOILER TEMPERATURE PROBE	60100076
10	THERMIC UPPER RACCORD 1/2 X1/2	30000200
11	FEMALE STRAIGHT 213 1/4 TUBE DE 6	30400165
12	CONICAL ELBOW RACCORD 1/4 x 1/4	30000215

## 12. Water inlet assembly exploded view.

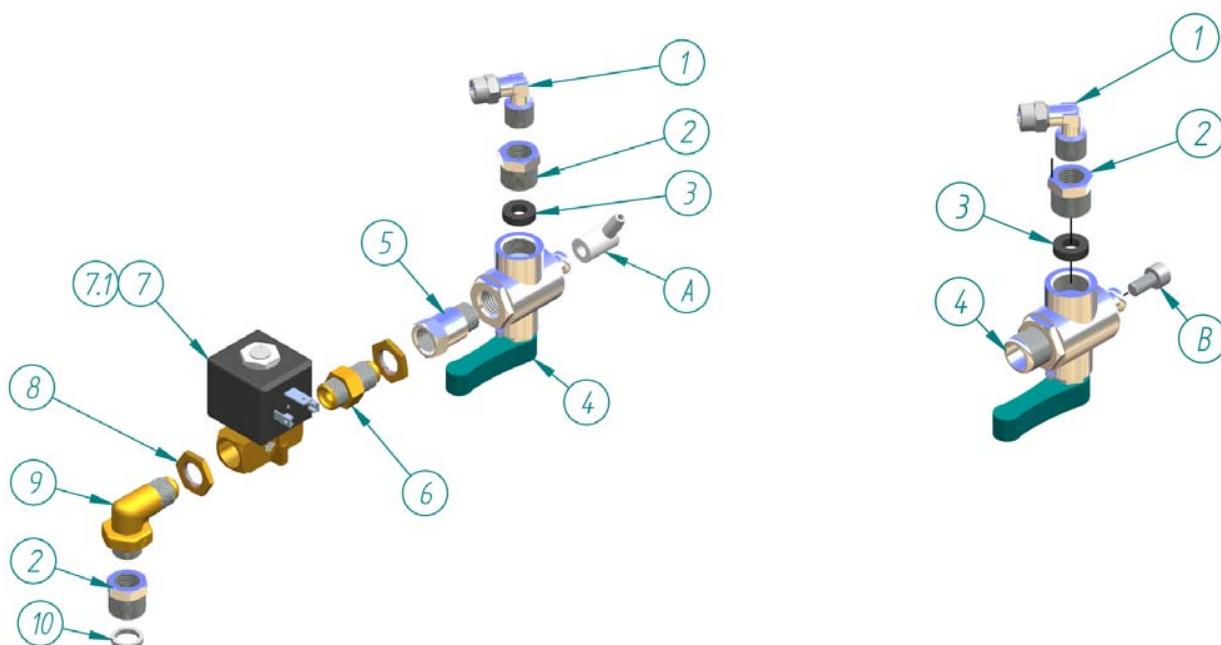

N°	Description	Item code
1	MALE ELBOW 1/4 TUBE 6 BATTERY	30400020
2	REDUCER MALE FEMALE 3/8x1/4	30000003
3	AXIX FLAT GASKET (15,5*7,5*4)	50000030
4	SOFTENER TAP INF/SUP	I000001A
4	SOFTENER TAP INF/SUP (1/4 MALE) TO CONSULT	-----
5	UNION MALE-FEMALE 1/4 (LABYRITH)	30400120
6	CONICAL RACCORD 1/4 x 1/4 ELECTRON	30000510
7	ELECTROVALVE 1/4 PARKER 220 V	60000100
7.1	ELECTROVALVE 1/4 PARKER 110V-60HZ	60000103
8	COUNTER NUT HEXAGONAL 1/4 PRESSURE STAT	30100010
9	CONICAL ELBOW RACCORD 1/4 x 1/4	30000215
10	BOILER RACCORD TEFLON GASKET 3/8 (11x14.5x2'5)	50010050
A	OFFICE PUMP PIPET	30400070
B	SCREW. DIN 912 - 6x10 A2 ALLEN	25091250

## 17. Electric and electronic devices.



Description	Item code
DIGITAL THERMOSTAT 230 V. PID	10200125
DIGITAL THERMOSTAT 115V	10200120



Description	Item code
STATIC RELAY 90-280	60800100



Description	Item code
RELAY PROTECTION CASE	60800103



60900080



60900082

Description	Item code
SWITCH TOGGLE OFFICE LEVA	60900080
CONMUTATOR SELECT ELEMENTS	60900082



60900081



60900083

Description	Item code
SCREEN PRINT PLATE ON/OFF	60900081
SCREEN PRINT PLATE I/O	60900083

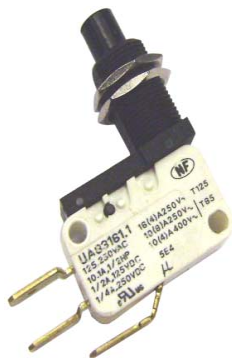

Description	Item code
MINISWITCH OFFICE	60900030



Description	Item code
ELECTROVALVE SPRING	55000040



## 17. Electric and electronic devices.



Description	Item code
ELEMENT 1200W-230V OFFICE	38012000
ELEMENT 1200/930W-125/110V OFFICE UL	38012001
ELEMENT.2000W 240V COPPER 6.25MM	38010001



Description	Item code
LEVEL REGULATOR SR 240V	60100101
LEVEL REGULATOR SR 115 V	60100106



Description	Item code
PRESSURE STAT PIRIS CE	60000008



Description	Item code
ELECTROVALVE 1/4 PARKER 220 V	60000100
ELECTROVALVE 1/4 PARKER 110V-60Hz	60000103



Description	Item code
ELEMENT PILOT 55 CM	60901001



Description	Item code
LEVEL PROBE 1/4 BRASS	60100040

